



Office: (800) 683-7248    Technical Support: (702) 651-3444    FAX: (702) 651-0214  
E-Mail: [techsupport@jcm-american.com](mailto:techsupport@jcm-american.com)    Web-Site: [www.jcm-american.com](http://www.jcm-american.com)

# *DBV-200*

## *Bill Validator*

*Operation and  
Maintenance Manual (Rev B)*

**JCM Part No. 960-000077**





# Table of Contents

Introduction .....	1
Model Identification .....	2
General Specifications .....	3
Installation Dimensions .....	4
Pin Assignments - Standard .....	5
Pin Assignments - Netplex .....	6
DIP Switch Settings .....	7
General DIP Switch Settings - Software .....	8
DIP Switch Settings - Test Mode .....	9
Troubleshooting - Error Codes .....	11
Troubleshooting Using the VM-401 .....	12
Disassembly Procedure .....	16
Auto-Calibration .....	20
Preventive Maintenance .....	21
Downloading to Flash Memory .....	21
PC/Laptop to DBV .....	22
DT-004 Download Tool .....	24
Multi Download Tool .....	25
Exploded View .....	27
Parts List .....	28



# Introduction

The JCM DBV-200 bill validator offers these features:

- The highest security for worldwide markets.
- Compatible with all JCM DBV series bill validators, direct replacement for DBV-14x.
- 4-way bill acceptance of bank notes.
- Six denominations are DIP switch selectable.
- Scanning time is less than two seconds.
- Uses 4-megabits of socketed EPROM or downloadable Flash memory.
- Automatic calibration.



**“B” Type**



**“A” Type**

# Model Identification

## How to read the Model Classification Number

### Model Numbers

DBV-200- \* \* \*\*  
(1) (2) (3) (4)

(1) **DBV-200 Bill Validator**

(2) **Type of Tray**

A - Standard straight tray

B - Flat IGT tray

\*(3) **Type of CPU board**

0 - 200 SS type Flash

1 - 200 SS type socket

2 - 200 SH/SG Flash

3 - 200 SH/SG socket

4 - 200 SS type Flash - Netplex

5 - 200 SS type socket - Netplex

\*\* (4) **Type of Software**

11 - ID - 011/015

23 - ID - 022/023

24 - ID - 024

26 - ID - 026/027

04 - ID - 004

03 - ID - 003

44 - ID - 044/045

43 - ID - 043

01 - ID - 001

**Example:** DBV-200 A 3 44

DBV-200 model bill validator with standard straight tray, 200 SH/SG socket, ID-044/045 software.

# General Specifications

Accepted bill denominations	U.S. Dollars - \$1, \$5, \$10, \$20, \$50, \$100 (and currencies of other countries)
Bill insertion	4-way
Acceptance rate	95%
Validation time	2 seconds or less from insertion to credit signal
Power supply	DC 12V ( $\pm$ 5%)
Power consumption	Standby: 11VA Operation: 20VA (Max. 20VA)
Environment	Operation: 32°F ~ 113°F Storage: -4°F ~ 140°F Humidity: 30% ~ 85% No direct sunlight Install indoors
Dimensions	W = 92.8 (3.6 in.), H = 87.5 (3.4 in.), D = 73.2 (2.8 in.)
Weight	Approx. 0.6 kg (1.6 lbs.)
Installation	Horizontal • For installations in other than a horizontal position, contact JCM

# Installation Dimensions

Front View

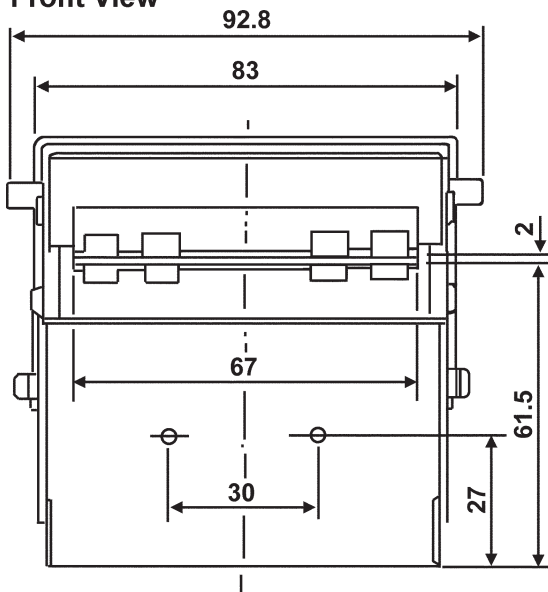

Side View

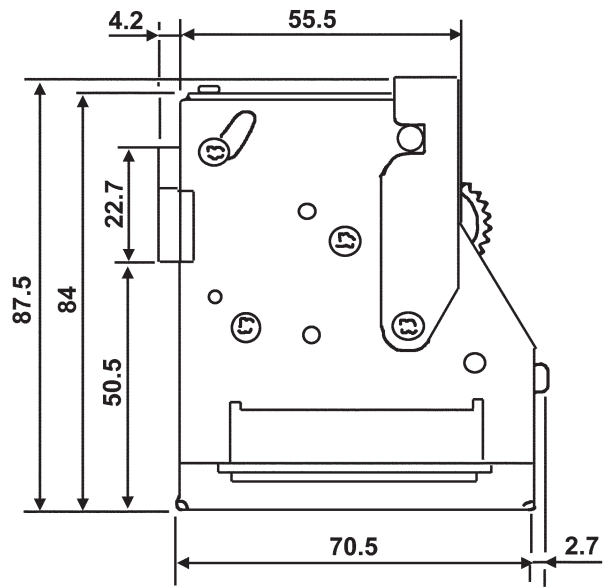

Bottom View

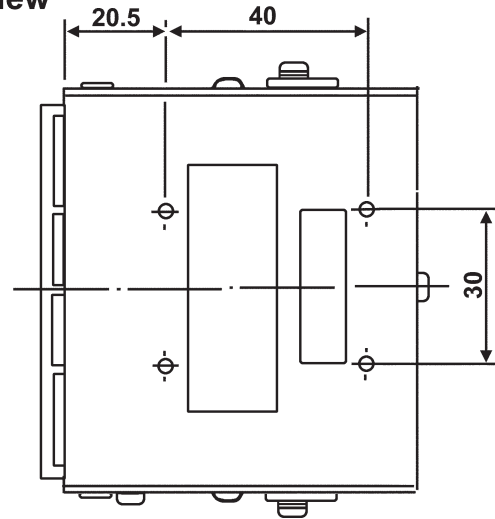

Unit: mm

# Pin Assignments - Standard

## DC Power Source

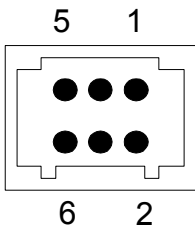

Header 53107-0650 (Molex)  
 Outside Connector  
 Clip 51041-0600 (Molex)  
 Housing 51030-0320 (Molex)  
 Terminal 50083-8\*00 (Molex)  
 (Wire AWG #24 - #30)

Pin No.	Signal Name	Function
1	Power source	DC +12V
2	Power source	DC GND
3	Photo coupler Output (+)	
4	Photo coupler Output (-)	
5	Photo coupler Input (+)	
6	Photo coupler Input (-)	

## Interface Connector

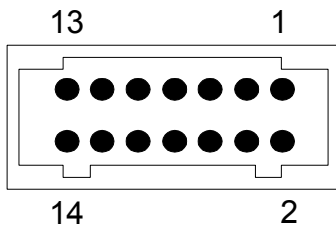

Header 53107-1450 (Molex)  
 Outside Connector  
 Clip 51041-1400 (Molex)  
 Housing 51030-0720 (Molex)  
 Terminal 50083-8\*00 (Molex)  
 (Wire AWG #24 - #30)

Pin No.	Signal Name	Function
1	NC	Prohibited
2	TTL Input 1	
3	TTL Output 1	
4	TTL Input 2	
5	TTL Output 2	TXD 1
6	TTL Input 3	
7	I/F GND	Interface GND
8	LED +	LED Power
9	TTL Input 4	RXD 1
10	TTL Input 6	RXD 2
11	TTL Output 3	
12	TTL Output 4	
13	TTL Output 5	TXD 2
14	TTL Output 6	

# Pin Assignments - Netplex

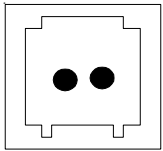

2 1

Header 53108-0250 (Molex)  
 Outside Connector  
 Housing 51030-0230 (Molex)  
 Terminal 50083-8\*14 (Molex)  
 (Wire AWG #24 - #30)

Pin No.	Signal Name	Function
1	+12V	DC +12V Power Supply
2	GND	DC 0V Power Supply

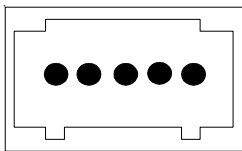

5 4 3 2 1

Header 53108-0550 (Molex)  
 Outside Connector  
 Housing 51030-0530 (Molex)  
 Terminal 50083-8\*14 (Molex)  
 (Wire AWG #24 - #30)

Pin No.	Signal Name	Function
1	M.RES	DC +12V
2	TXD	Data transmission line
3	+12V	Interface power supply
4	RXD	Data receive line
5	GND	Interface power supply

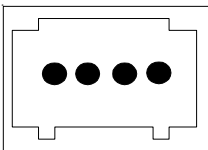

4 3 2 1

Header 53108-0450 (Molex)  
 Outside Connector  
 Housing 51030-0430 (Molex)  
 Terminal 50083-8\*14 (Molex)  
 (Wire AWG #24 - #30)

Pin No.	Signal Name	Function
1	LED+	LED Drive line (anode)
2	LED-	LED Drive line (cathode)
3	NC	Not used
4	NC	Not used



# General DIP Switch Settings - Software

These tables only refer to DIP switches 7 through 10 on Bank-1.

## Software ID: 011/015

Function	Switches ON	Switches OFF
Specify ID-011	None	7 through 10
Specify ID-015	10	7 through 9
Use ACK/REJ Signal	None	7 through 10

## Software ID: 022/022B/023/023B

Function	Switches ON	Switches OFF
Specify ID-022	10	7 through 9
Specify ID-023	None	7 through 10
Specify ID-022B (ID-022 + SDS Coupon)	9 and 10	7 and 8
Specify ID-023B (ID-023 + SDS Coupon)	9	7, 8, and 10

## Software ID: 044/045P/045W

Function	Switches ON	Switches OFF
Specify ID-044	None	7 through 10
Specify ID-045/P/W (Accepts coupons)	10	7 through 9

## Software ID: 004

Function	Switches ON	Switches OFF
Accept currency and coupon	10	7 through 9
Accept currency	None	7 through 10

# DIP Switch Settings - Test Mode

## Auto-calibration mode

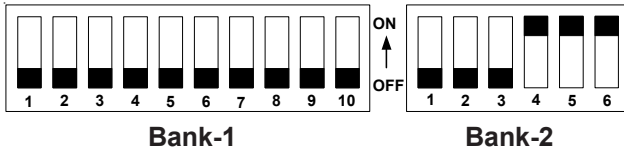

With the power off, set the DIP switches for the test. Turn on the power. The unit will cycle, then insert the calibration paper, black side first (See page 18).

## Download (19200 Baud)

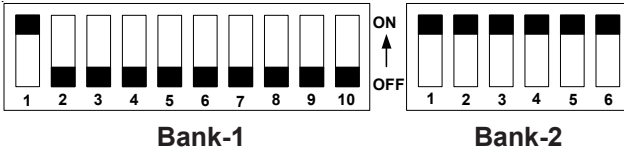

With the power off, set the DIP switches for the test. Turn on the power. 2 LEDs flash in sequence.

## Download (9600 Baud)

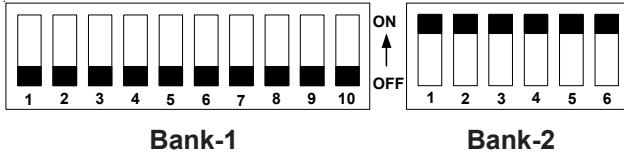

With the power off, set the DIP switches for the test. Turn on the power. 2 LEDs flash in sequence.

## Download (38400 Baud)

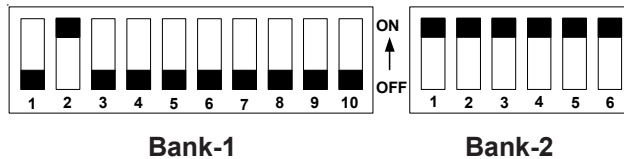

With the power off, set the DIP switches for the test. Turn on the power. 2 LEDs flash in sequence. **Caution:** Use at own risk.

## Bill Registry without stacker

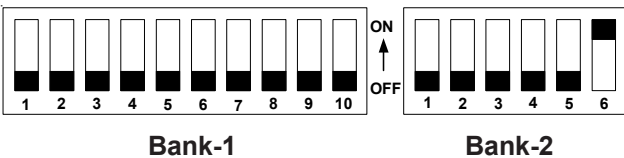

With the power off, set the DIP switches for the test. Set Bank-2 #6 on. Turn on the power. Turn Bank-2 #6 off. The motor will cycle. Insert a bill (see page 11).

## Bill Registry with stacker

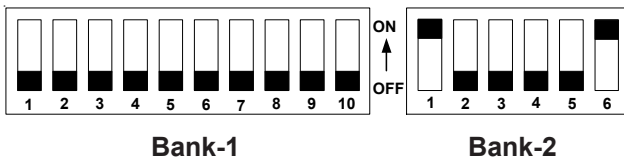

With the power off, set the DIP switches for the test. Set Bank-2 #6 on. Turn on the power. Turn Bank-2 #6 off. The motor will cycle. Insert a bill (see page 11).

## Solenoid Test

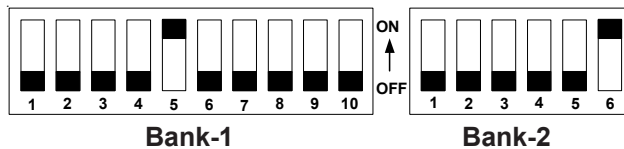

With the power off, set the DIP switches for the test. Turn on the power. All three LEDs will light, the left one will blink until Bank-2 #6 is turned off.

## DIP Switch Settings - Test Mode (Cont.)

### Carrier and Storage Test

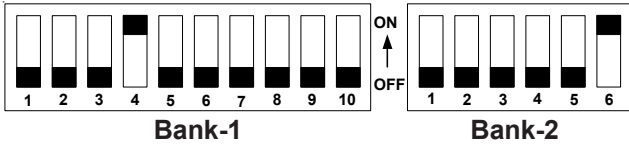

With the power off, set the DIP switches for the test. Turn on the power. All three LEDs will light, the left one will blink until Bank-2 #6 is turned off.

### Stacker Performance Test

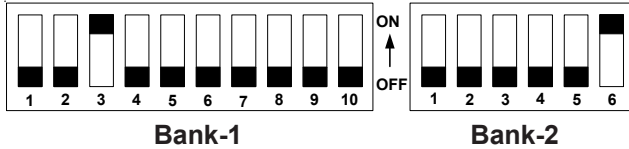

With the power off, set the DIP switches for the test. Turn on the power. All three LEDs will light, the left one will blink until Bank-2 #6 is turned off.

### Reverse Motor Rotation



With the power off, set the DIP switches for the test. Turn on the power. Turn off Bank-2 #6 and the motor will rotate.

### Normal Motor Rotation



With the power off, set the DIP switches for the test. Turn on the power. Turn off Bank-2 #6 and the motor will rotate.

# Troubleshooting

## Abnormal Codes

LED Blinks	Problem	Possible Cause
1	Cash box full	<ul style="list-style-type: none"> <li>Cash box may be full</li> <li>Motor not working</li> <li>Encoder sensor not working</li> <li>Encoder gear cracked</li> </ul>
2	Jam in Cash box	<ul style="list-style-type: none"> <li>Pusher mechanism jammed</li> <li>Stacker encoder sensor not working</li> <li>Pusher home sensor</li> </ul>
3	Jam in transport	<ul style="list-style-type: none"> <li>Cover open</li> <li>Stacker lever problem</li> <li>Bill in carrying path</li> </ul>
4	Jam in bill path	<ul style="list-style-type: none"> <li>Object blocking sensors</li> <li>Sensor problem</li> </ul>
5	Motor speed error	<ul style="list-style-type: none"> <li>Motor speed</li> <li>Encoder sensor failure</li> <li>Bad encoder gear</li> </ul>
6	Motor stop error	<ul style="list-style-type: none"> <li>Motor not working</li> <li>Bad Encoder gear</li> <li>Encoder sensor not working</li> </ul>
8	Solenoid error	<ul style="list-style-type: none"> <li>Solenoid not working</li> <li>Solenoid sensor error</li> </ul>
10	Cash box removed	<ul style="list-style-type: none"> <li>Home position sensor</li> <li>No cash box (SS units only)</li> <li>Cash box not seated properly</li> </ul>
12	Cheat condition	<ul style="list-style-type: none"> <li>Sensors indicate possible sensor manipulation</li> </ul>

## Bill Return Codes

LED Blinks	Problem	Possible Cause
1	Crooked insertion	<ul style="list-style-type: none"> <li>Bill inserted crookedly</li> <li>Entrance sensor problem</li> </ul>
2	Center mag pattern error	<ul style="list-style-type: none"> <li>Pattern detection error</li> </ul>
3	Sensor error during standby mode	<ul style="list-style-type: none"> <li>Sensors detected object in bill path</li> </ul>
4	Data amplitude error	<ul style="list-style-type: none"> <li>Sensors malfunctioning</li> <li>Out of calibration</li> </ul>
5	Transport feed error	<ul style="list-style-type: none"> <li>Bill not detected by transport feed sensor within specified time</li> </ul>
7	Photo sensor error	<ul style="list-style-type: none"> <li>Sensor sample does not match program pattern</li> <li>Possible sensor malfunction</li> </ul>
8	Photo level error	<ul style="list-style-type: none"> <li>Detect double/overlap bill</li> <li>Dirty bill</li> </ul>
9	Returned by inhibit settings	<ul style="list-style-type: none"> <li>Denomination disabled by acceptor DIP switch</li> </ul>
10	Returned by host	<ul style="list-style-type: none"> <li>Denomination disabled by game program</li> </ul>
12	Detected other bill while in stack mode	<ul style="list-style-type: none"> <li>Entrance sensor malfunction</li> <li>Object blocking entrance sensor</li> </ul>
13	Bill length error	<ul style="list-style-type: none"> <li>Bill length not within programmed parameters</li> <li>Reflective sensor problem</li> <li>Encoder gear problem</li> </ul>
14	Color pattern error	<ul style="list-style-type: none"> <li>Irregular color/shade/markings</li> </ul>
15	Mag pattern error	<ul style="list-style-type: none"> <li>L or R magnetic sensors</li> </ul>

# Troubleshooting

## Using the VM-401

Eight additional tests can be performed on the DBV-200 using the VM-401.

Plug the two cables coming from the right side of the VM-401, one of them 6-pin, the other 14-pin, to the two receptacles on the DBV-200. Attach a 120V power cord to the back of the VM-401.

Put all of the DIP switches on the VM-401 (located on the front of the machine) in the ON position. Put DIP switch #6 on DS-2 on the DBV-200 in the ON position. Turn on the VM-401.

The BSY light will come on, and the ABN light on the VM-401 will blink and the display should read **no 01**. The three LEDs on the DBV-200 will light, and the left one will blink.

The first two tests verify the proper motor speed. With **no 01** in the display window, turn the ENABLE/DISABLE switch to ENABLE. The DBV-200 motor will run, and the lights will describe motor speed.

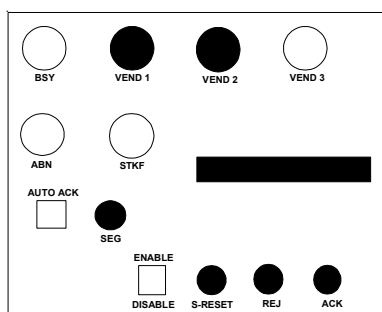

**Motor speed is fast**

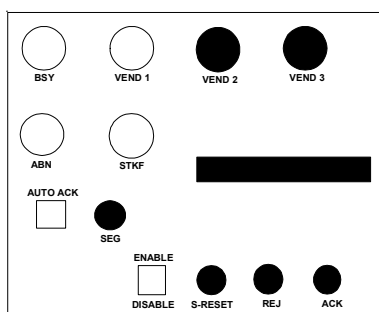

**Motor speed is accurate**

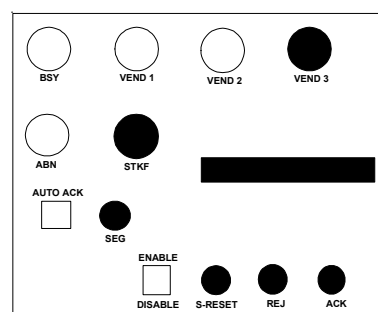

**Motor speed is slow**

Turn the ENABLE/DISABLE switch to DISABLE. Push the REJ button. The display will change to **no 02**. Hold down the REJ button and turn the ENABLE/DISABLE switch to ENABLE. The DBV-200 motor will run and the lights will describe motor speed. Turn the ENABLE/DISABLE switch to DISABLE.

The third test verifies the condition of the head sensors. Push the ACK button down and hold it there while turning the ENABLE/DISABLE switch to ENABLE. There should be a **no 03** in the display. Place a bill or note in the acceptor. Use the large white gear on the back to advance the bill or note.

VEND 1 lights when the left entrance sensor path is broken.

VEND 2 lights when the right entrance sensor path is broken.

VEND 3 lights when the left reflective sensor path is broken.

STKF lights when the right reflective sensor path is broken.

Push the ENABLE/DISABLE switch to DISABLE.

## Using the VM-401 (Cont.)

For the rest of these tests, the DBV-200 must be placed in a stacker with a cash box. Attach the stacker relay harness to the receptacle on the DBV-200.

Hold down the REJ and ACK buttons while turning the ENABLE/DISABLE switch to ENABLE. The display should show **no 04**. The stacker motor will cycle.

Hold down the S-RESET button (**no 05** should appear in the display). Turn the ENABLE/DISABLE switch to ENABLE. See if the VEND lights come on. Use the following table to determine the cause.

Error Code			Possible Location
VEND 1	VEND 2	VEND 3	
●			Stacker motor
	●		Encoder sensor Stacker solenoid
●	●		Validator sensor Bill in validator
		●	Stacker sensor Bill in stacker
●		●	Cash box full
	●	●	Pushing unit Stacker encoder

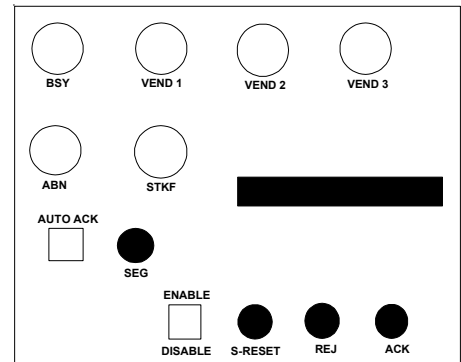

To test the stacker solenoid, hold down the REJ and S-RESET buttons (**no 06** will appear in the display) and turn the ENABLE/DISABLE switch to ENABLE. If the solenoid is functioning properly, there will be an intermittent click, and the VEND 2 light will blink.

**NOTE:** This test does not apply to horizontal style transports (Bally, Sigma, Williams, etc.).

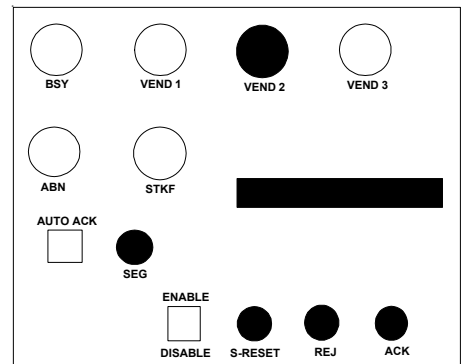

## Using the VM-401 (Cont.)

Hold down the ACK and S-RESET buttons (**no 07** will appear in the display) and turn the ENABLE/DISABLE switch to ENABLE. Manually interrupt the paths between the sensors and the light sources as indicated in the illustration. When the path is interrupted, it will turn on a light on the VM-401.

1. Feed-in sensor (phototransistor part)
2. Solenoid lever sensor
3. Feed out sensor (phototransistor part)
4. Stacker encoder sensor

5. Feed out sensor (LED part)
6. Feed in sensor (LED part)

Not shown is the pusher home position sensor located at the base of the stacker frame.

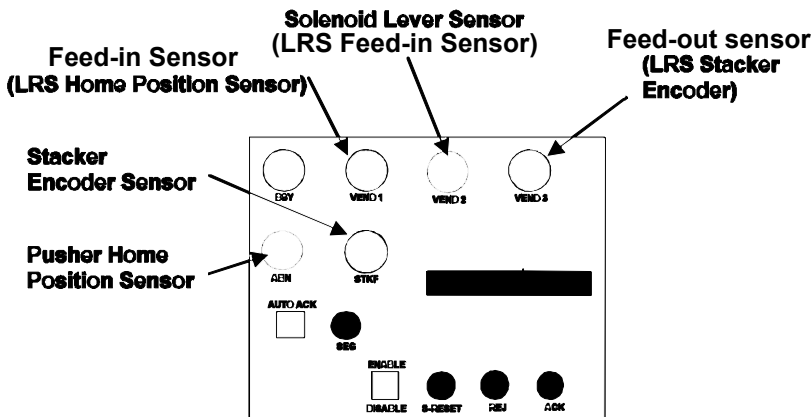
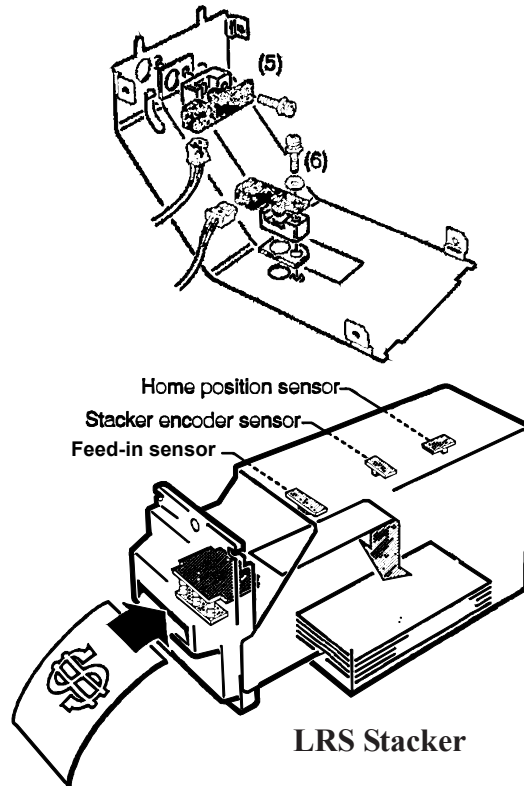
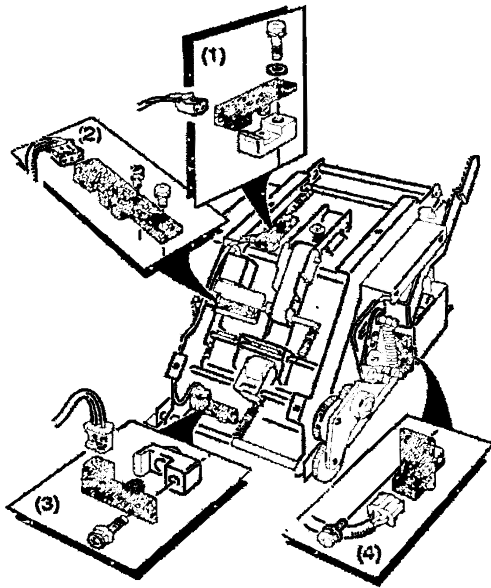

## Using the VM-401 (Cont.)

The final step is the Bill Acceptance Test. This test can be done with or without the stacker. Without a stacker, the DIP switches remain unchanged. With a stacker, turn off the power, and turn Dip switch 2-1 ON. Turn the power back on before enabling the test.

Hold down the REJ, ACK, and S-RESET buttons (**no 08** will appear in the display) while you turn the ENABLE/DISABLE switch to ENABLE. The motor will cycle once.

Insert bills of various denominations into the validator. All three VEND lights will come on, but one or two lights will stay on a second longer, indicating the bill denomination. The denomination is also shown in the display (a \$100.00 bill is displayed as A0). The VM-401 must be powered down to end this test.

VEND 1	VEND 2	VEND 3	Denomination
●			\$1.00
	●		\$5.00
●	●		\$10.00
		●	\$20.00
●		●	\$50.00
	●	●	\$100.00

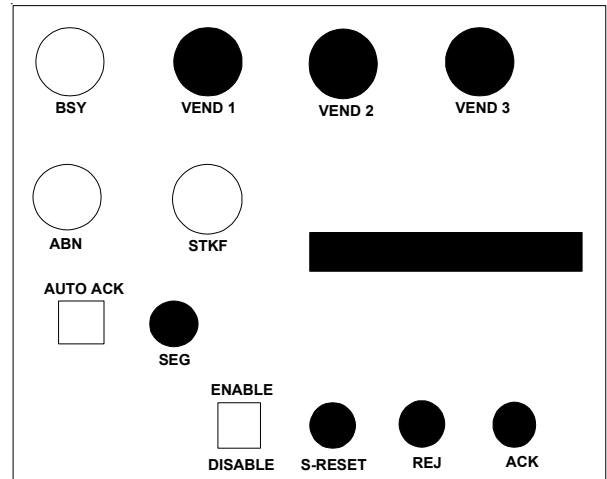

# DBV-200 Disassembly Procedure

## Removing the CPU board

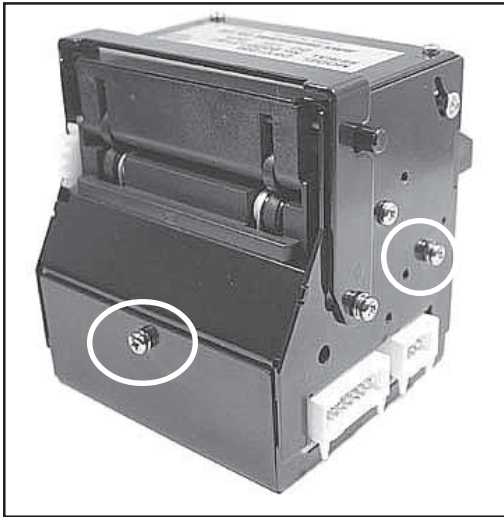

1. Remove three (3) screws, two from the sides and one from the back.

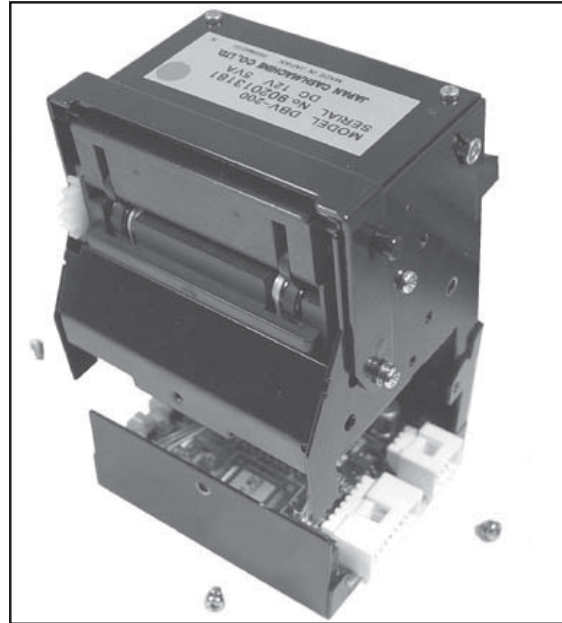

2. Separate the tray from the unit.

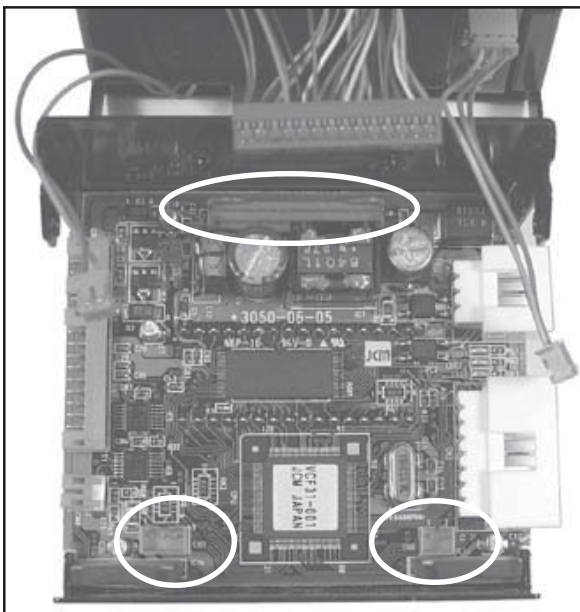

3. Disconnect the three (3) wire harnesses to remove the CPU board.

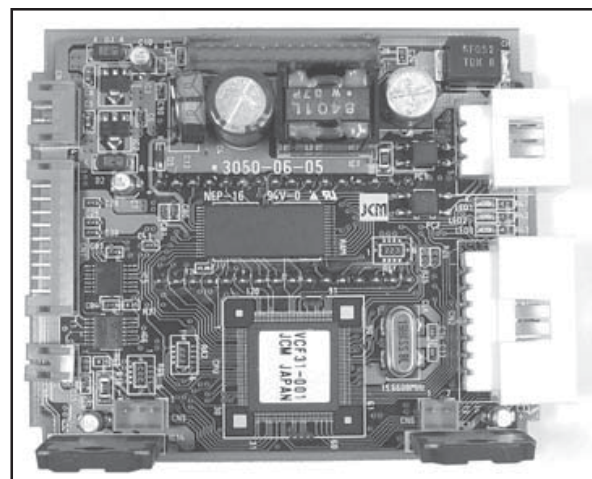

Disconnected CPU board.

## Disassembly Procedure (Cont.)

### Removing the upper sensor board



4. Remove two (2) screws on the sides in the curved slots, and the two (2) screws on top to remove the cover.



5. Removing the cover is a 3-step process. First, lift the front edge of the cover.

**WARNING:** Be gentle. There are two (2) small tabs that can easily be broken off if too much force is used.



6. Second, slide the cover back.

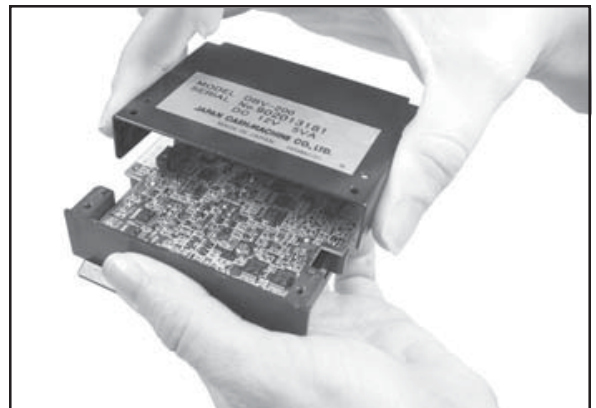

7. Third, lift the cover off the sensor board.

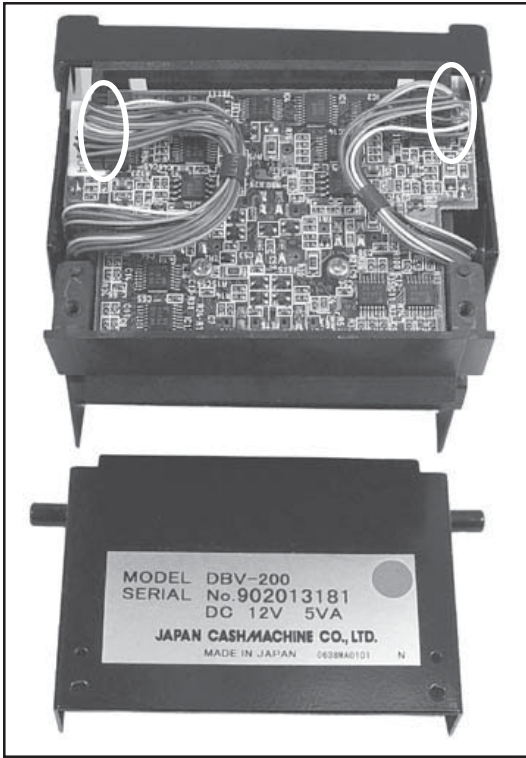

8. Remove the two (2) wire harnesses.

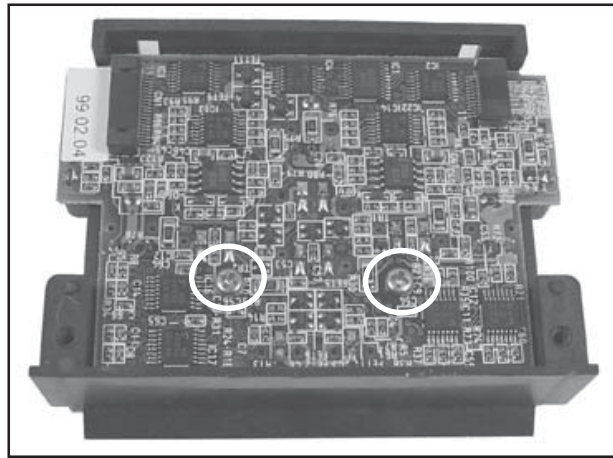

9. Remove the two (2) screws in the sensor board to remove it.

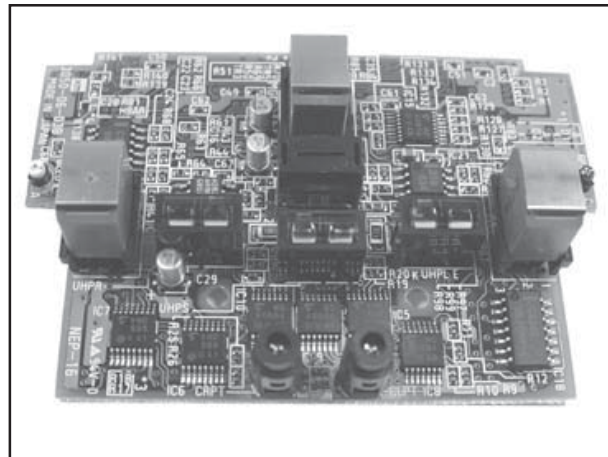

Upper sensor board removed.

### Removing the motor, belt, lower sensor board and encoder board

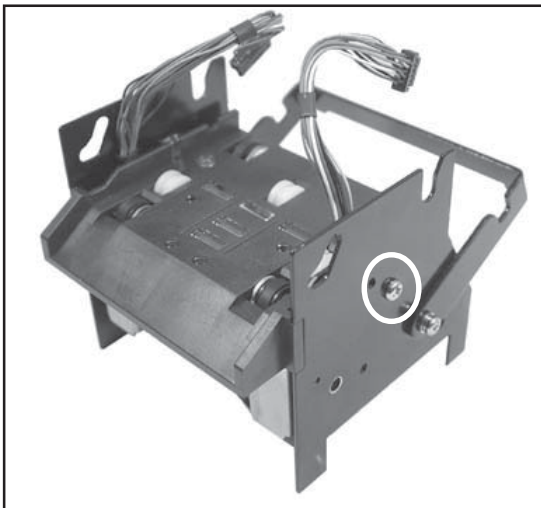

10. Remove two (2) screws, one on either side, and pull the internal mechanism free.



Internal mechanisms including gears and motor  
**WARNING:** The outside gear can fall off the spindle easily.

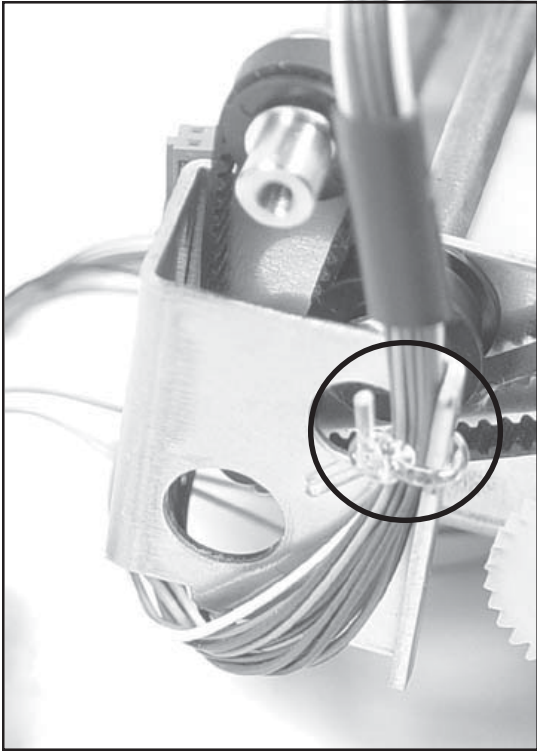

Do not remove the wire ties on each side.

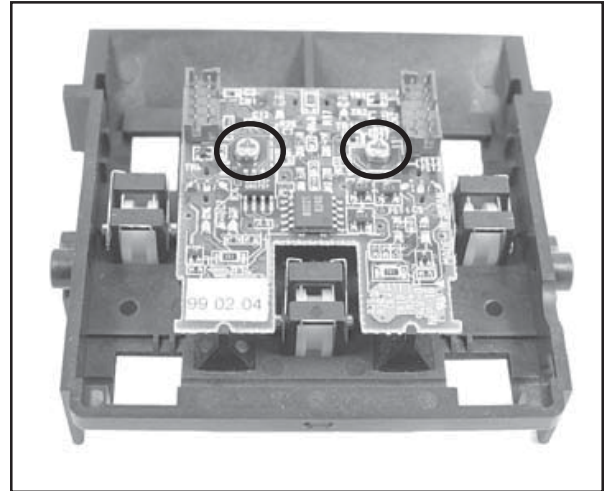

12. Remove two (2) screws to separate the sensor board from the lower tray guide.

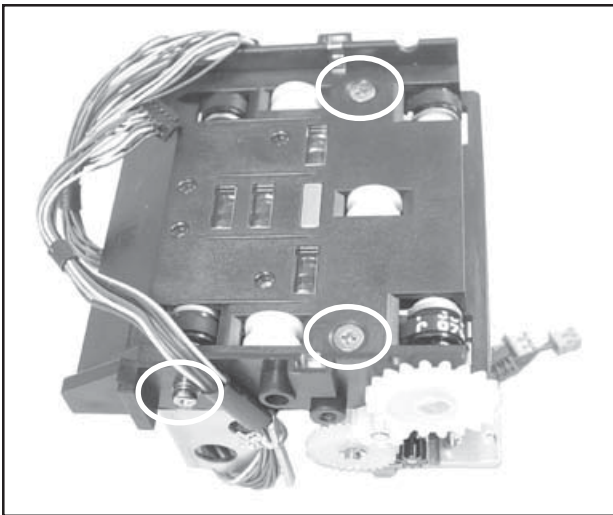

11. Remove four (4) screws, two from the top and two from the sides of the housing, disconnect the harness, and remove the lower tray guide. Remove the large gear also.

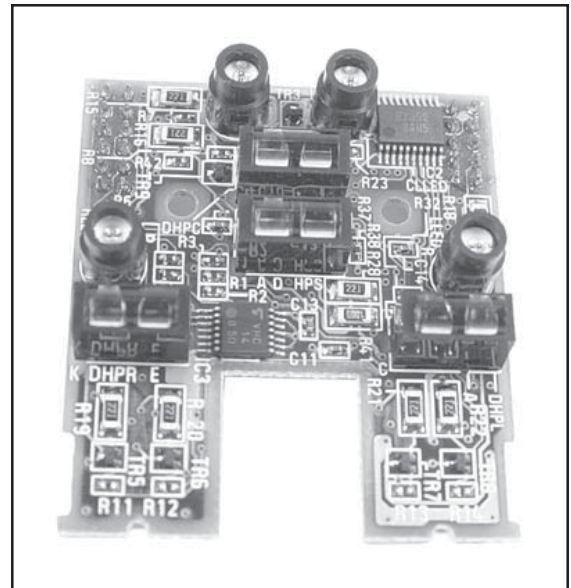

The lower sensor board removed.

# DBV-200 Auto-Calibration

1. Make sure there is no power connected to the unit.
2. Set DIP switches DS-2 #4, 5, 6 ON.

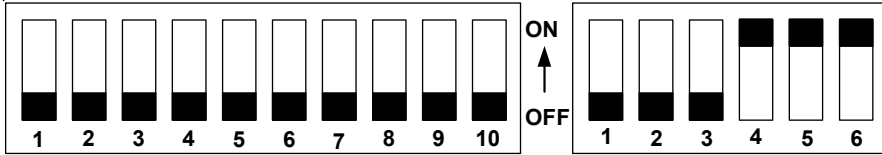

3. Insert the LED test light (Part No. 400-100018) in the DBV-200.
4. Apply power to the unit (6-pin connector).
5. Head motor will cycle and stop. The unit is ready to calibrate.
6. Insert the DBV-200 calibration paper (Part No. 057619), black side first.

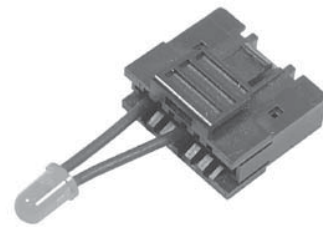

**Part No. 400-100018**

The unit will cycle the calibration paper back and forth a few times, then eject the paper.

Look at the appropriate indicators to verify a correct calibration or an error. Use either the 14-pin LED test light (Part No. 400-100018), or the bezel light. Rapid blinks indicate a successful calibration. If the light blinks at half-second intervals, and the machine does not eject the paper, there is an error. Count the blinks and correlate with the table below:

# of Blinks	Error	Corrective Action
3	Entrance sensor error	Test entrance sensors (TX and RX)
5	Gain error white level adjustments	Replace upper or lower sensor board
6	Digital/analog error	Replace lower sensor board
7	Barcode sensor error	Replace upper sensor board
9	Magnetic setting error	Replace upper sensor board
10	Write-in error	Replace lower sensor board
11	Black level error	Replace upper or lower sensor board

# Preventive Maintenance

Replace belts if frayed, slick, and/or worn.

It is important to keep the bill path, rollers, and belts clean. The sensor lenses are transparent, and made of a polymer material. Handle them with care.

To clean the lenses, use a lint-free cloth and a mild non-abrasive detergent such as liquid dish soap mixed with water.

**Do not use alcohol for cleaning.**

**Important Note: After wiping, inspect the lenses to ensure that they have not been moved out of position, and are not flush with the bill path.**

**Note: JCM does not recommend cleaning cards, cleaning pads, or cleaning solutions of any kind.**

## **Cash Box Preventive Maintenance (P/M)**

Do periodic P/M on the cash boxes to ensure proper operation. Use compressed air to blow out the paper fibers and other debris that builds up over time. Check the belts and all moving parts for wear and proper positioning. If the unit does not operate properly, it can cause bill jams.

After completing the P/M, Auto-Calibration is recommended ( see Page 18).

# Downloading to Flash Memory

These procedures are used to download a more recent, or alternative, software program into a DBV-200 equipped with Flash memory. There are three (3) methods available for downloading:

- PC to DBV-200
- DT-004 to DBV-200
- DBV-200 Multi-Download Tools to DBV-200s

## DIP switch Settings

The DIP switch settings for all three (3) procedures are identical. On DS-1, set No. 1 to ON all the rest to OFF. On DS-2, set No. 1 through 6 to ON.

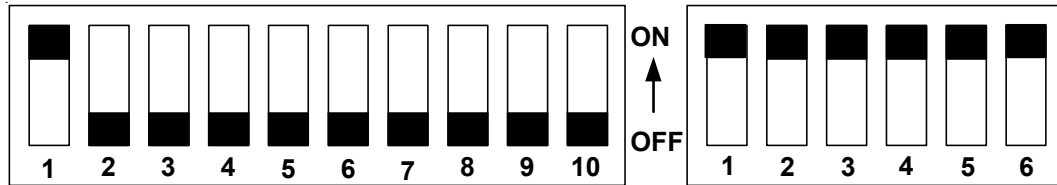

## PC/Laptop to DBV-200

The following equipment is necessary to perform this procedure:

- IBM-compatible PC or laptop with an available serial port.
- JCM-supplied diskette, Part No. 501-000023.
- JCM Power Supply, Model PS15-006.
- PS15-006 to DBV-200 Adapter Harness, Part No. 400-100072.
- Appropriate software diskette for the DBV-200 to be upgraded. This software must be ordered separately, and is dependent on approval by gaming jurisdictional authorities for actual use. Customers should consult JCM's Customer Service/Parts Sales departments concerning approved versions for jurisdictions of intended use.

## Procedure

It is recommended that a folder be created on the hard disk labeled "Download." Copy the two files on the JCM-supplied diskette to the "Download" folder. Those files are:

DWN211.exe  
DWNNET.exe

Remove that diskette and replace it with the software diskette. Copy that file to the same folder.

Use the 400-100072 harness to attach the PS15-006 power supply to the DBV-200. Plug the power supply into a 120V receptacle. The two LEDs on the DBV-200 should start blinking. Attach the cable from the power supply to the serial port on the computer.

Place the computer in MS-DOS mode, and go to the "Download" folder. There will be at least three (3) files in the folder, the two previously mentioned .exe files plus the actual software file.

Enter the following command to begin the download process:

```
DWN211 <software filename.extension> 1 252 246 n (n=com port either 1 or 2) then press  
ENTER.
```

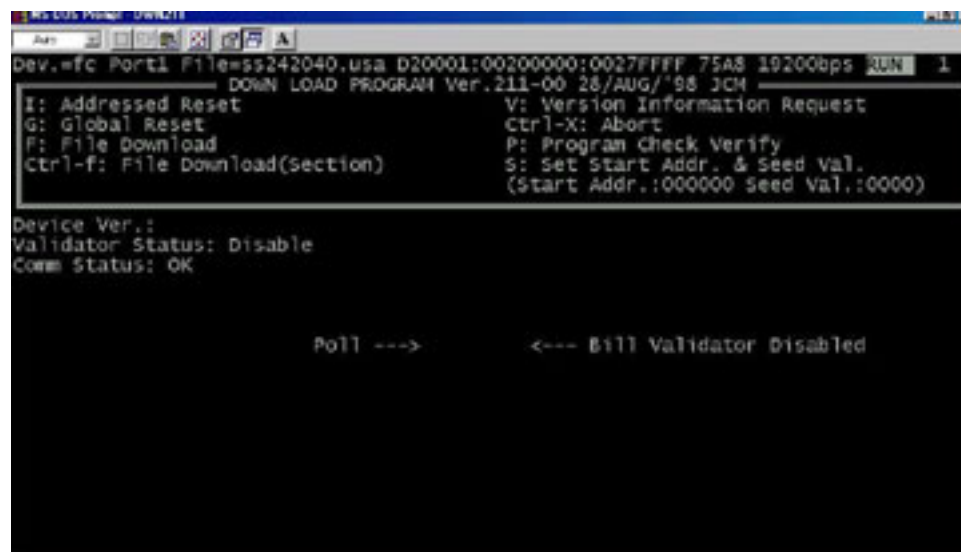
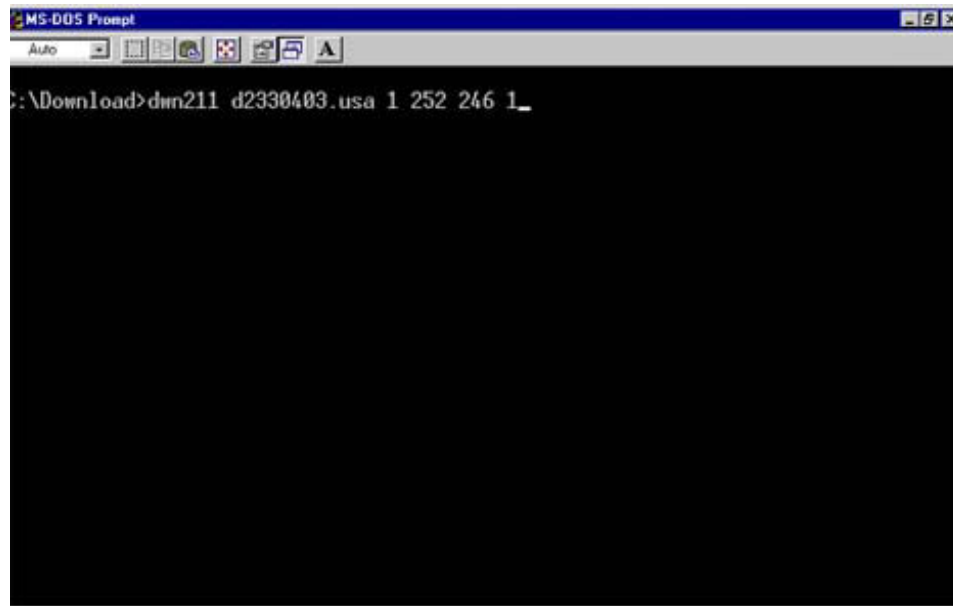

Once communication between the PC and the DBV-200 is established, start the download process by pressing the shift F. The LEDs on the unit will change the blinking sequence, and messages indicating the progress of the download will appear on the screen.

After a few minutes, this message will appear on the screen:  
DOWNLOAD END AND CONFIRM. Press the "Shift" V key to verify the update if necessary.

After completing the download procedure, Auto Calibration is recommended (see page 20).

## DT-004 Download Tool (Part No. 501-000022)

The following equipment is necessary to perform this procedure:

The DT-004 Download Tool (Part No. 501-000022)

Two wire harnesses

400-100065 Power Harness

400-100066 Data Harness

JCM software on a 4MB master EPROM

JCM Power Supply – PS15-007 (Part No. 550-100041)

DBV-200 Adaptor Harness (400-100067)



### Procedure

Place the 4-Meg EPROM in the DT-004, properly align the notch, and use the lever to lock it down.

Plug the three harnesses into the DT-004 as shown.

Connect the 400-100067 adaptor harness to the PS-15-007 power supply.

Connect the other two harnesses (400-100065 and 400-100066) to the DBV-200 as shown.

Plug the power supply into a 120V outlet.

Turn on the DT-004 download tool.

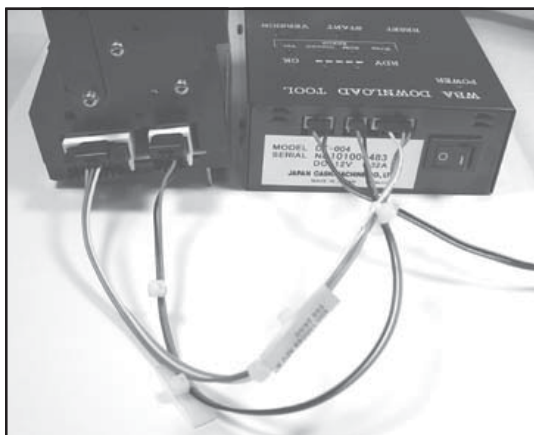
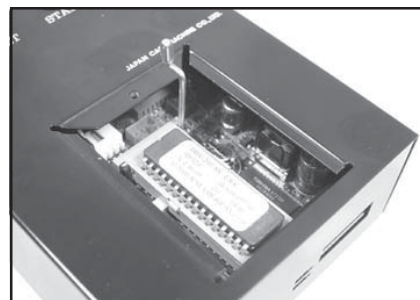

400-100067 To Power Supply  
400-100065 To DBV-200  
400-100066 To DBV-200

The orange POWER light and the green RDY lights will come on. The LEDs on the DBV-200 will blink.

Push the START button to begin downloading the software. The green RDY light will begin blinking. LEDs on the DBV-200 change their blinking sequence. This indicates the download process has begun. After a few minutes, the orange light beside the RDY light will begin blinking also. Then all four lights in the row light up. The last one is the OK light. The LEDs on the DBV-200 return to their standard blinking pattern. This indicates the download was successful.

Turn off the DT-004 and remove the wire harnesses from the DBV-200. If another unit is to be upgraded, attach the two wire harnesses and repeat this procedure.

After completing the download procedure, Auto Calibration is recommended (see page 20).

**DBV-200 Multi Download Tool (Part No. 701-000021)  
and Multi Download Adapter (Part No. 701-000020)**

The following equipment is necessary to perform this procedure:

- JCM DBV-200 Multi Download Tool, MDT, (Part No. 501-000015)
- JCM DBV-200 Software on a 4 Meg EPROM chip
- JCM Multi Download Adapter, MDA, (Optional) (Part No. 501-000016) to download more than ten (10) units simultaneously

MDT (Download Out) to MDA (Download In) with Harness (Part No. 400-000081)

- DBV-200 to Multi Download Tool and Multi Download Adapter Harness (Part No. 400-000080)
- DBV-200-B424 to Multi Download Tool and Multi Download Adapter Harness (Part No. 400-000078) to J5 through J9 only



**DBV-200 Multi Download Tool**



**DBV-200 Multi Download Adapter**

### **Procedure (Multi Download Tool)**

1. Make sure the power switch is in the OFF position.
2. Connect the MDT to a 115V power source.
3. Place the download switch in the RST position.
4. Properly orient the notch on the master EPROM then insert in the ZIF socket and lock it in place.
5. Set the DIP switches on the DBV-200s as described on Page 22.
6. Connect up to ten DBV-200s to the Multi Download Tool using the harnesses (Part No. 400-000080).

Connect the DBV-200-B424s to the Multi Download Tool using the harnesses (Part No. 400-000078) to receptacles J5 through J9 only.

7. Place the power switch in the ON position. The red and green LEDs light up.
8. Place the download switch in the PRG position. The red LED will go out.
9. When the download is complete, the red LED flashes.
10. Place the power switch in the OFF position.
11. Disconnect the DBV-200s from the MDT.
12. If there are additional DBVs to be downloaded repeat Steps 3 through 11.

### **Procedure (Multi Download Adapter)**

1. Make sure both the Multi Download Tool and the Multi Download Adapter power switches are OFF.
2. Attach the Multi Download Tool (Download Out connection) to the Multi Download Adapter (Download In connection) with the harness (Part No. 400-000081).
3. Attach as many as 10 DBV-200s to the Multi Download Tool and another 10 to the Multi Download Adapter using the appropriate harnesses (400-000080).
4. Follow Steps 7 through 12 above.

After completing the download procedure, Auto Calibration is recommended (see page 20).

# Exploded View

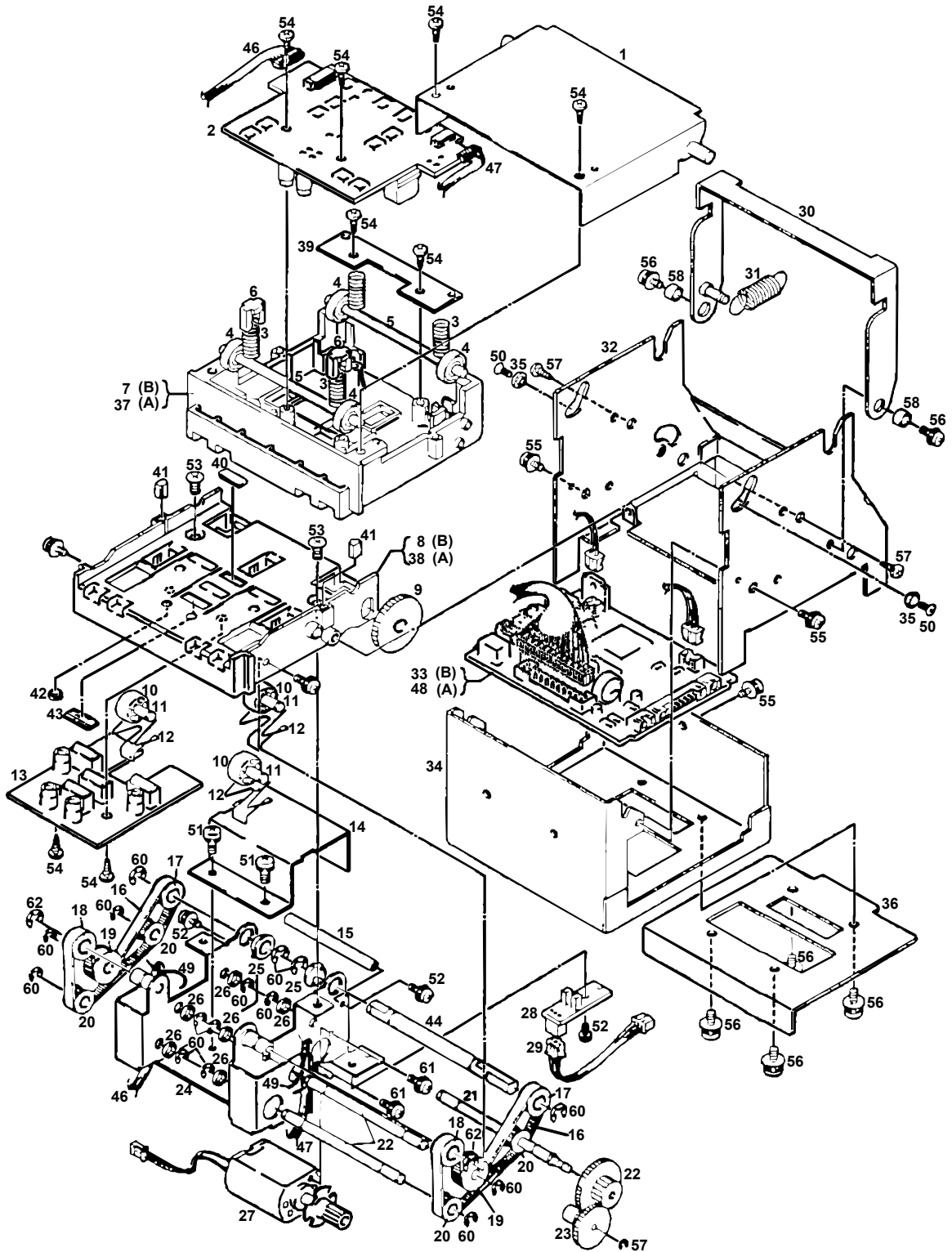

# Parts List

Ref No.	Part No.	Description	Qty.
1	063342	Upper Frame Assy.	1
2	063360	Sensor Board, Upper	1
3	052639	TR Spring 2	4
4	063336	Roller A	4
5	063347	R Shaft	2
6	052518	SP Stopper	2
9	059526	Con Gear	1
10	063326	Roller M	3
11	063348	M Shaft	3
12	163353	MG Spring	3
13	063359	Sensor Board, Lower	1
14	063339	Noise Killer	1
15	063349	GM Beam	1
16	063354	Timing Belt	2
17	063357	Pulley D	2
18	063355	Pulley A	2
19	063325	Roller B	2
20	063356	Pulley B	4
21	063346	PG Shaft	1
22	063345	P Shaft	2
23	063323	Gear B	1
24	063343	Gear Frame AS	1
25	063327	DS Bearing	2
26	063332	SH Bushing	6
27	063368	Motor	1
28	063390	Photo Interrupter Substrate	1
29	063364	Photo Interrupter Harness	1
30	063341	Closing Lever AS	1
31	044820	Tension Spring	1
32	063340	Main Frame	1

Ref No.	Part No.	Description	Qty.
33	063358	CPU Board (ROM)	1
	063839	B0 CPU Board (Flash)	1
	300-100057	B1 CPU Board (ROM)	1
	063837	A2 CPU Board (Flash)	1
	300-100058	A3 CPU Board (ROM)	1
	066813	B4 CPU Board (Flash)	1
	066812	B5 CPU Board (ROM)	1
34	063337	CPU Base	1
35	026297	Hinge	2
36	064546	Validator Base	1
37	063335	Upper Guide A	1
38	063334	Lower Guide A	1
39	063338	SP Stopper	1
40	063331	Level Plate	2
41	063333	Prism	2
42	063329	Sensor Cover B	6
43	063328	Sensor Cover A	8
44	063344	Drive Shaft	1
45	063324	Gear M	1
46	063362	Sensor Harness 1	1
47	063363	Sensor Harness 2	1
48	063358	CPU Board (ROM)	1
	063839	CPU Board (Flash)	1
49	054609	Ø2 Cord Clamp	2
50	063351	M2 x 5 Flat Screw	2
51	003595	M2.6 x 4 Screw with Washer	2
52	005555	M2.6 x 6 Screw with Washer(s)	5
53	006021	M2.6 x 4 Flat Screw	2
54	049531	M2.6 x 8 Screw (P-tite)	8
55	046977	Ø3 x 4 SEMS	3
56	046975	M3 x 6 Screw with Washer (S)	6
57	063350	M3 x 6 Screw (P-Tite)	2

<b>Ref No.</b>	<b>Part No.</b>	<b>Description</b>	<b>Qty.</b>
58	046997	Ø3 x 2.5 Bushing	2
59	046982	Ø2 E Ring (SUS)	1
60	046983	Ø3 E Ring (SUS)	15
61	064817	M2.3 x 4 Set Screw	2
62	003718	No. 5103-18 C-Type Clip	2





925 Pilot Road, Las Vegas, Nevada 89119

Office: (800) 683-7248, Tech. Support: (702) 651-3444, FAX: (702) 651-0214

E-mail: [techsupport@jcm-american.com](mailto:techsupport@jcm-american.com)

<http://www.jcm-american.com>